

Akarina 05/06

Operating manual for Akarina
(Hydroculture system + LED)

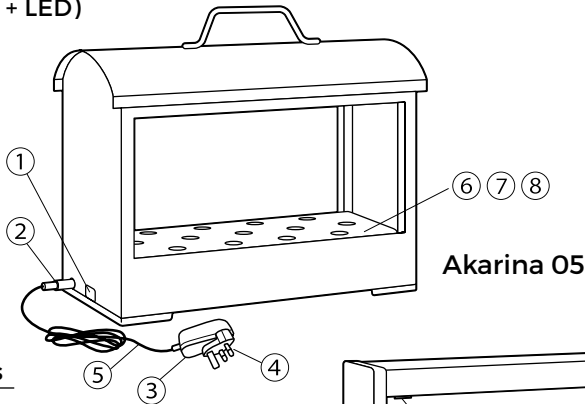

Name of components

1. On/Off switch
2. Jack plug
3. AC adapter
4. Plug
5. Power cable
6. Cover
7. Culture tray
8. Irrigation tray

Akarina 06

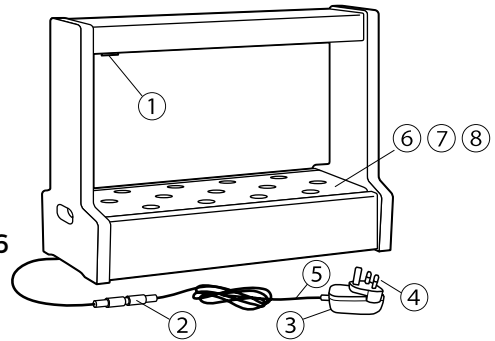

Note

Parts and accessories;
make sure that you find
the correct number of
parts and accessories.

Dimensions of Akarina 05

L 470 mm x B 175 mm x H 355 mm

Dimensions of Akarina 06

L 455 mm x B 205 mm x H 345 mm

Input voltage

AC 100-240 V 50/60Hz

Output voltage

DC 12 V 2 A

Length of power cable

1.5 m

Content

1x main unit with integrated LED
1x irrigation tray
1x cover for irrigation tray
1x culture tray

14x plastic closure caps
48x rooting sponges
1x power pack
1x operating manual

Please have ready

One large dish, watering can (or PET bottle)

Use the accessories; the main unit does not function alone. Note: Use only tap water.
Not mineral water, distilled water, purified water or any other liquid.

Procedure

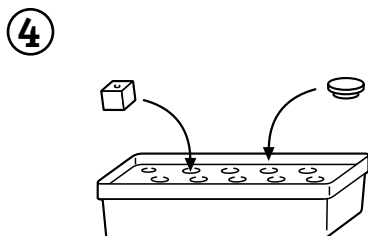
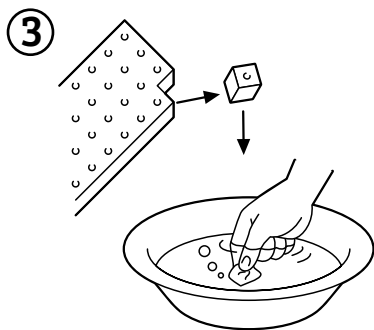
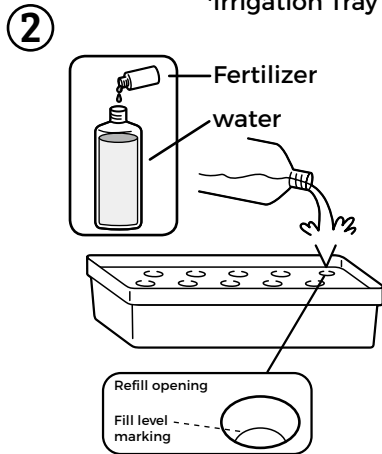
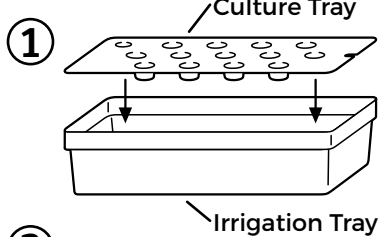

1. Place the irrigation tray and culture tray into the main unit

2. Make up the nutrient solution first then pour it into the irrigation tray (see below and diagram to left).

Dilute the resulting liquid fertilizer with water from watering can or PET bottle. Follow the specific instructions on the liquid nutrient packaging for correct dilution.

Place the culture tray on top of the irrigation tray then pour the prepared mixture into the refill hole of the culture tray so it fills the irrigation tray underneath up to the fill level marking.

Please store the remaining liquid in a dark place so that it can be used for topping up if the water level falls below the mark; add nutrient solution until the water level reaches the mark.

3. Preparing the sponge cube

Separate the sponge cubes at the perforations.

Submerge the sponge in a large bowl of water. Press each sponge four or five times under water to expel the air. The rooting sponges may go yellow in sunlight but this does not impair their function.

4. Insert the rooting sponges

Place the water-filled rooting sponges into the holes in the culture tray (indented side uppermost).

Select the spacing between the sponges according to the seed-type. The upper surface of the sponge cube should be level with the culture tray. If the sponge cube is not inserted deeply enough it can not absorb the feed and the seed will not germinate. Do not place sponges into the water metering hole. Cover any unused holes with a closure cap.

5

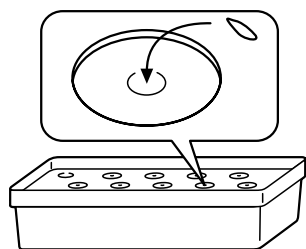

5. Seeding

Place the seed in the centre of the indentation in the sponge cube.

Place the tray cover over the culture tray to maintain humidity until germination occurs (seeds split and small green leaves appear).

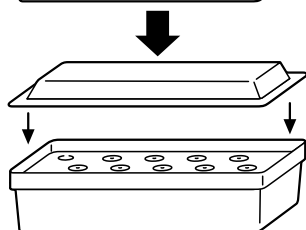

6. Monitor the seeds

Check the seeds daily after planting. Remove the cover when the seeds have split and small pale green leaves have appeared. The germination time varies depending on the type of seed and the temperature.

Connect the jack plug to the main unit and plug the power cable into the wall socket.

6

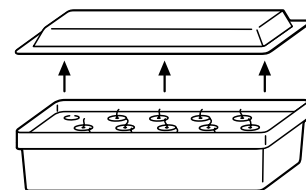

Switch on the LED

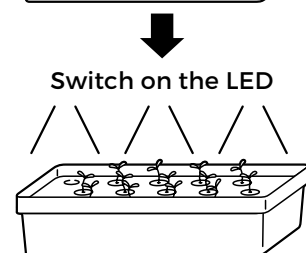

Lettuce, rocket and herbs such as basil can grow under 24-hour lighting although some plants such as spinach require to have less lighting time. The lighting time (number of hours the light is on per day) varies according to the conditions. Increase the lighting time if growth is too slow.

7

7. Growth and harvesting

If the leaves are growing too closely together make more room for them by removing an entire neighbouring cube or by harvesting the product.

Two harvesting methods: Remove the whole plant as soon as it is the required size. Harvesting the leaves: Remove the fullygrown leaves, leaving the shoots in the centre. If no new shoots grow, harvest the whole plant and start a fresh batch.

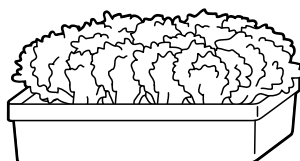

Sowing tips

Sow 1 or 2 seeds per sponge. Too many seeds interfere with growth.

Too little water in the sponge cube inhibits germination. Grow only one type of seed in each pot. Mixed seeds inhibit germination.

Leaving the cover off encourages the growth of moss.

Each plant requires its own ideal temperature for germination. In principle most plants germinate at around 20°C.

Check the germination temperature given on the seed packet. Mop up any spilled or dripped nutrient solution or water immediately as it can cause rust or corrosion.



Instructions for use

- The recommended operating temperature is between 15°C and 30°C.
- Growth varies according to conditions. Green moss grows depending on conditions. This does not have an adverse effect. If you want to remove it, remove the plants from the culture tray and wash the irrigation tray with washing-up liquid.
- The rooting sponges may go yellow in sunlight but this does not impair their function.

Care and storage

Switch off the appliance and remove the power cable. Now carefully remove the irrigation tray and the culture tray without spilling the contents.

- The remaining liquid can be disposed of via the normal waste pipe or can be used to water other plants.
- Rinse off the irrigation tray, culture tray and cover, using washing-up liquid for heavy soiling if necessary. Rinse and dry everything thoroughly to prevent rust and corrosion during storage.

Symptom	Possible cause	Solution
LED goes out during operation	Temporary loss of power or sudden drop in voltage	<ul style="list-style-type: none">• Switch mains in "OFF" position. Check connection.• Turn the appliance on.
LED is not switched on.	Power cable is not connected.	<ul style="list-style-type: none">• Switch the appliance off and then on again after waiting 3 seconds.

- If the problem persists switch the appliance off and consult your dealer.
- For questions concerning operation, care and repair first contact the dealer from whom you bought the appliance.

CONTACT

Olympia Lighting Fixtures Industries, Ltd.
2-9-8, Honkomagome, Bunkyo City, Tokyo 113-0021, Japan
e-mail: sale@olympia-jp.co.jp web: www.olympia-jp.co.jp/world
(Own brands AKARINA / MotoM)

www.motom-jp.com/en

Safety instructions

Read the safety instructions before using the appliance and use it properly. The important instructions are included here in order to prevent danger and injury to the user.

This takes the form of a step-by-step guide to dangers and injuries resulting from improper use.

 Statement on danger to life and serious injury.







 Statement on possibility of injury and damage to property.

The following symbols indicate the instructions which should be followed.



 Indicates that this should not be carried out.

 Indicates that this should be carried out.

Warning

-  • Avoid damage to power cable and plug. Damaged parts cause electric shock, short circuit and fire.
-  • Using with wet hands; do not touch the plug with wet hands. This causes electric shock.
-  • Remove dust regularly from the power cable. Dust combined with humidity causes damage to insulation and fire.
 - Insert the plug correctly. Incomplete contact causes electric shock or heat-induced fire.
 - Do not use damaged or loose plugs.
-  • Do not place fabric or paper or other flammable materials over the appliance or use them to cover it. This causes fire.
-  • Do not carry out any modifications or changes yourself. This causes fire or injury from electric shock.
-  • Pull out the plug if you notice any irregularities. Then contact your dealer.

Note

-  • Your appliance has a limited life span. Interior components may be damaged without this being obvious from the outside. Regular maintenance and care are recommended for this reason. Long-term use without maintenance / care can cause electric shock/fire.
 - Disconnect the appliance from the power supply for maintenance as otherwise there is a risk of electric shock.
-  • Use in a wet environment: Do not use in a damp or humid atmosphere such as a bathroom or out of doors. This product is not waterproof.
-  • Do not place appliances next to each other as this increases humidity. This can result in a shorter life for the appliance or cause fire.
 - Do not combine with a dimmer switch. This causes fire.
 - Do not lean against the appliance or knock into it. This causes electric damage.
 - Do not look directly into the LED. This causes pain in the eyes.